



KENNEDY VALVE

# C515 4" - 20" RESILIENT WEDGE GATE VALVE

## CERTIFICATIONS

ISO 9001

ISO 14001

ISO 45001

AWWA C515



\*Listings specific to product

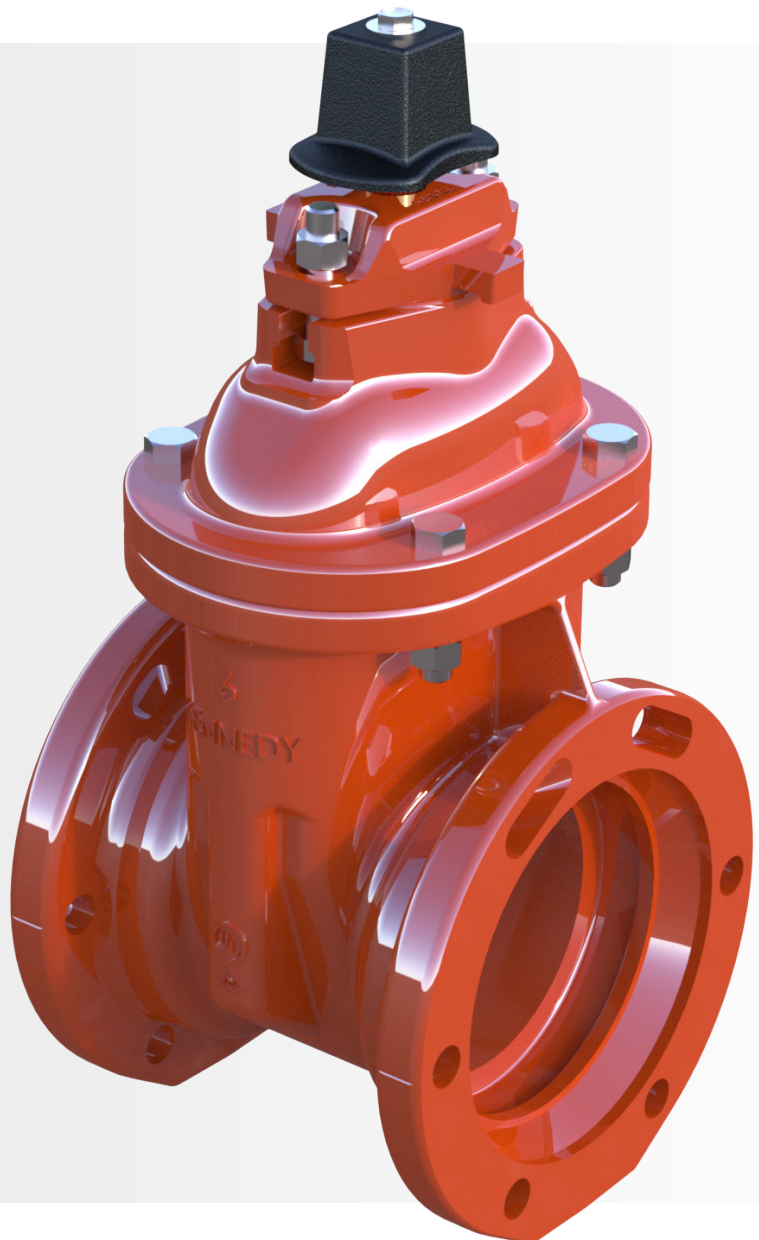

WWW.KENNEDYVALVE.COM

In the early 1980's Kennedy recognized and increased the requirements and escalating maintenance cost of water systems in the United States. Kennedy responded by introducing the first RW (Resilient Wedge) Valve in America. This introduction revolutionized the valve market in the U.S. Kennedy was the first to introduce, and still leads in, the design and technical development of the bubble tight resilient seating valve. The RW Valve, with its unique features and benefits, is the first to be manufactured with both AWWA and UL/FM approval for all water system requirements.

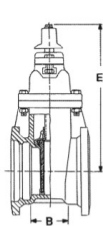

**7571**  
Mechanical Joint  
4"-20"

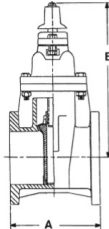

**7561A**  
Flanged  
4"-20"

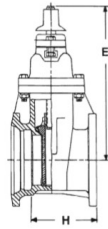

**7572**  
Flanged X  
Mechanical Joint  
4"-12"

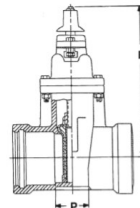

**7595**  
Push on for  
SDR PVC  
4"-12"

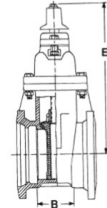

**7576**  
Mechanical  
Cutting in Joint  
4"-12"

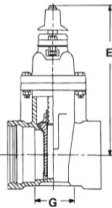

**7901**  
Tyton Ends for D.I.  
and C900 PVC Pipe  
4"-16"

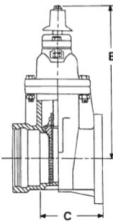

**7902**  
Flanged x Tyton  
4"-12"

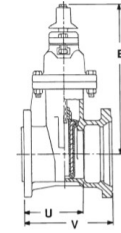

**7950**  
Tapping x MJ  
Tapping Valve  
4"-20"

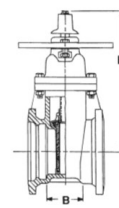

**7071**  
Mechanical Joint  
Post Indicator Valve  
4"-16"

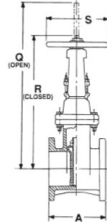

**7068A**  
Flanged OS&Y  
4"-12"

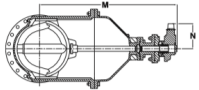

Bevel Gearing  
Horizontal Installation  
All End Styles  
14"-20"

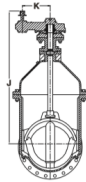

Spur Gearing  
Vertical Installation  
All End Styles  
14"-20"

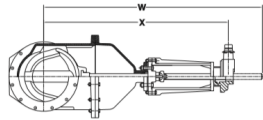

OS&Y Bevel Gearing  
Horizontal Installation  
All End Styles  
14"-20"

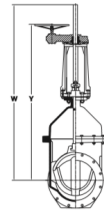

OS&Y Spur Gearing  
Vertical Installation  
All End Styles  
14"-20"

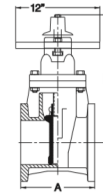

**7701A**  
Flanged Post  
Indicator Valve  
4"-16"

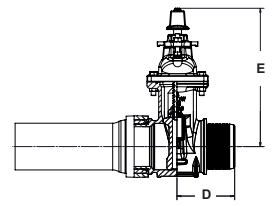

HDPE  
AWWA Only  
IPS DR11 FM Approved  
4"-12"

**NOTE:** It is recommended that valves be installed with stems vertical when used in raw sewage or sludge applications or in water with excessive sediment. Flanged end connections not recommended for buried service.

**No. of Turns  
to Full Open**

VALUE SIZE	A	B	C	D	E	G	H	J	K	M	N	P	Q	R	S	U	V	NO GEAR	GEARED	W	X	Y	
4"	9	4-1/2	6-3/4	6-1/8	14-3/4	4-5/8	6-3/4					4-1/2	22-3/4	18-1/4	10	6-3/4	9-1/4	13-1/2					
6"	10-1/2	5-1/2	7-7/8	7-13/16	19	5-1/4	8					5	30-1/8	23-3/4	12	8	10-1/2	19-1/2					
8"	11-1/2	8-1/8	8-1/2	9-1/8	22-1/2	5-5/8	9-3/4					5-1/2	37-3/4	29-1/4	14	10-3/4	13-1/4	25-1/2					
10"	13	10-1/2	10	11-3/8	26-1/2	7	11-3/4					7	45-3/4	35-3/8	18	11-3/4	14-7/8	31-1/2					
12"	14	10-3/4	11-1/4	11-3/4	30	8-1/2	12-7/8					8-1/2	53-1/8	40-3/8	18	12-3/8	15	37-3/4					
14"	15	10			37-3/4	10-1/2	13-1/2	52-1/8	8	48-5/8	9-1/8		74-3/4	59-3/4	22	13-1/4	16-3/4	52	100	76	59-7/8	64-1/2	
16"	16	10			37-3/4	10-1/2	13	51-1/8	8	47-5/8	9-1/8		74-3/4	59-3/4	22	12-3/4	16-1/4	52	100	76	59-7/8	64-1/2	
18"	17	11-3/4					14-7/8	58	12	55-3/4	10-1/8					14-5/8	16-1/8		189	90-7/8	70-1/8	74-5/8	
20"	18	11					14-1/2	57	8	54-3/4	10-1/8					14-1/2	18		189	90-7/8	70-1/8	74-5/8	

**NRS with POST PLATE**

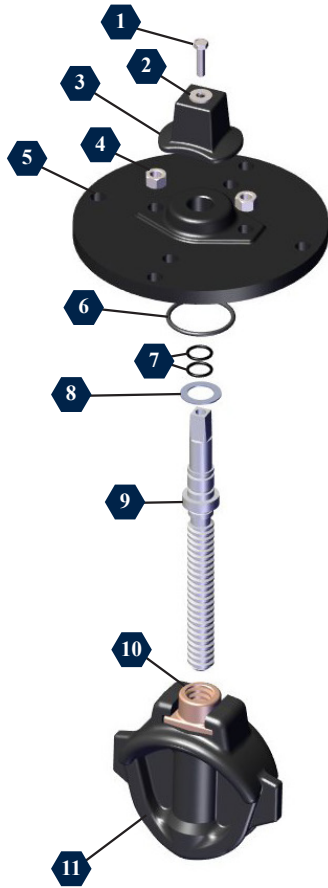

**NRS**

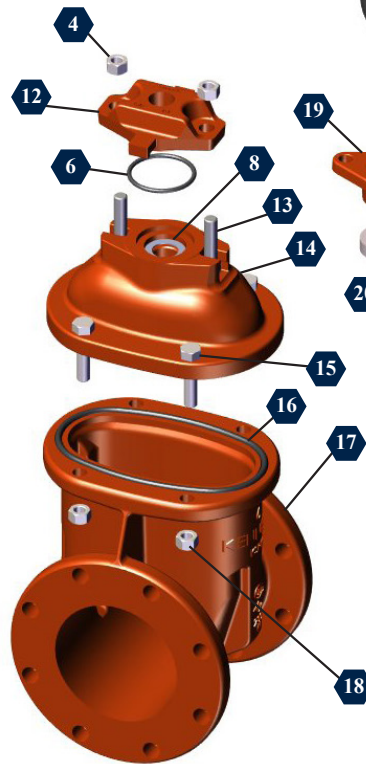

**OS&Y**



NO.	DESCRIPTION	MATERIAL	NO.	DESCRIPTION	MATERIAL
1	Op-Nut Bolt	Stainless Steel	17	Body	Ductile Iron
2	Op-Nut Washer	Stainless Steel	18	Cover / Body Nut	Stainless Steel
3	Op-Nut	Ductile Iron	19	Packing Gland	Ductile Iron
4	Post Plate / Stuffing Box Nut	Stainless Steel	20	Packing	Garlock Style 18
5	Post Plate	Cast Iron	21	OS&Y Wheel Nut	Bronze
6	Post Plate / Stuffing Box O-Ring	Rubber	22	Hand Wheel	Cast Iron
7	Stem O-Rings	Rubber	23	OS&Y Cover	Ductile Iron
8	Thrust Teflon Washer	Plastic	24	OS&Y Yoke Washer	Plastic
9	NRS Stem	Stainless Steel	25	OS&Y Yoke Nut	Bronze
10	NRS Stem Nut	Bronze	26	Packing Stud	Stainless Steel
11	Resilient Wedge	EPDM Encapsulated Ductile Iron	27	OS&Y Stem	Stainless Steel
12	Stuffing Box	Ductile Iron	28	OS&Y Stem O-Ring	Rubber
13	Post Plate / Stuffing Box Plate Bolt	Stainless Steel	29	OS&Y Stem Pin	Stainless Steel
14	NRS Cover	Ductile Iron	30	OS&Y Stem Head	Stainless Steel
15	Cover / Body Bolt	Stainless Steel	31	Handwheel Yoke Washer	Brass
16	Cover / Body O-Ring	Rubber			

# SPECIFICATIONS & FEATURES

## Kennedy Valve AWWA C515 Resilient Wedge Gate

Valves meet or exceed the requirements of AWWA standard C515, UL-262/FM-1120/1130, ULC - Underwriters' of Canada, and NSF Listed.

Available in either non-rising stem (NRS) or outside screw & yoke (OS&Y). NRS style is available with post plate for adaptation with an indicator post.

	RATED PRESSURE	SEAT TEST PRESSURE	SHELL TEST PRESSURE
AWWA 2" - 48"	250 PSI	250 PSI	500 PSI
ULFM 2-1/2" - 12"	200 PSI	300 PSI	500 PSI
ULFM 14" - 16"	250 PSI	375 PSI	500 PSI
ULFM 18" - 24"	200 PSI	300 PSI	500 PSI

- 1 | 2"-12" C515 RSGV shall conform to the latest version of AWWA Standard C-515 covering Resilient Seated Gate Valves for Water Supply Service.
- 2 | The valves shall have a ductile iron body, and bonnet.
- 3 | The wedge shall be completely encapsulated with EPDM rubber.
- 4 | The sealing rubber shall be permanently bonded to the wedge to meet ASTM tests for rubber metal bond ASTM D249.
- 5 | Valves shall be supplied with O-Ring seals at all joints (no gaskets are used in the valve design).
- 6 | The valves shall be either non-rising or rising stem, opening by turning (left or right) and provided with 2" square operating nut or a handwheel with the "Open" and an arrow cast in the metal to indicate the direction to open.
- 7 | All stems shall operate with bronze stem nuts independent of stem (in NRS valves). NRS stems shall have (2) O-Rings located above thrust collar and (1) O-Ring below. All stem O-Rings shall be replaceable with valve fully opened and subjected to full pressure. The NRS stems shall also have (2) low torque thrust bearings located above and below stem collar to reduce friction during operation.
- 8 | OS&Y (rising stems) shall be of bronze. Pre-grooved stem for supervisory switch.
- 9 | Waterway shall be smooth, unobstructed & free of pockets, cavities, & depressions in the seat area. Valves shall be able to accept a full size tapping cutter.
- 10 | The body, bonnet, and stuffing plate shall be coated with fusion bonded epoxy, both interior and exterior on body and bonnet. Epoxy shall be applied in accordance with AWWA C550 and be NSF61 and NSF372 certified.
- 11 | Each valve shall have a maker's name, pressure rating, and year in which it was manufactured cast in the body. Prior to shipment from the factory, each valve shall be tested by hydrostatic pressure equal to requirements of both AWWA and UL/FM.
- 12 | All internal parts shall be accessible without removing the body from the line.
- 13 | Valves shall have all brass components cast and assembled in the USA and shall be manufactured by Kennedy Valve Company or equal.



KENNEDY VALVE

## ORDERING INFORMATION

PH: 800-782-5831  
607-734-2211

KNV.SALES@MCWANE.COM  
WWW.KENNEDYVALVE.COM

## KENNEDY VALVE

1021 E. WATER ST.  
ELMIRA, NY  
14902-1516



For Generations